

FAIR FRIEND • ENGINEERING • EXCELLENCE • LEADERSHIP • EXPERTISE • RELIABILITY



HEADQUARTERS
 No. 186, Yong Chi Road, Taipei, Taiwan.
 Tel: +886-2-2763-9696
 Fax: +886-2-2768-0636/37/39
 www.ffg-tw.com
 E-mail: chairom@fairfriend.com.tw

FEELER[®] FAIR FRIEND GROUP
FAIR FRIEND ENTERPRISE CO., LTD.

FEELER MACHINE TOOLS DIVISION
 No. 12, Jingke Rd., Nantun Dist., Taichung City, Taiwan
 Tel: +886-4-2359-4075 (MAIN), 2359-4845 (SALES DEP.)
 Fax: +886-4-2359-4873
 www.feeler.com
 E-mail: sales@feeler.com



ISO 9001
ISO 14001



Website



Facebook

VMP *SERIES*

Vertical Machining Center

FEELER VMP SERIES

Vertical Machining Center Provides State-of-the-art Efficiency For Increased Profitability

Whether you require in high precision parts machining or general mold making, Fair Friend new VMP-Series Vertical Machining Centers offer unbeatable dependability.

The VMP-Series is a well-engineered high precision unit, making it ideal for various precision industrial requirements. It promises dramatic productivity gains with many integrated features. Its rugged structure is manufactured from high quality cast iron, assuring optimum rigidity and stability for years of dependable operation. Machine structure design is subject to ANSYS and NASTRAN Finite Element Analysis to achieve the highest standards of machine accuracy and reliability.

Reinforced A-shape column bottom is combined with massive base for extra rigid support. 10,000 rpm spindle speed produces the fine surface effect required by precision mold. With the points above and more excellent features combination, you get the most competitive edge for your precision jobs.



■ VMP-23Aapc



■ VMP-32Aapc



■ VMP-30A



■ VMP-40A



■ VMP-50A



■ VMP-65A

Perfected structure design brings you lifetime accuracy, rigidity and stability !

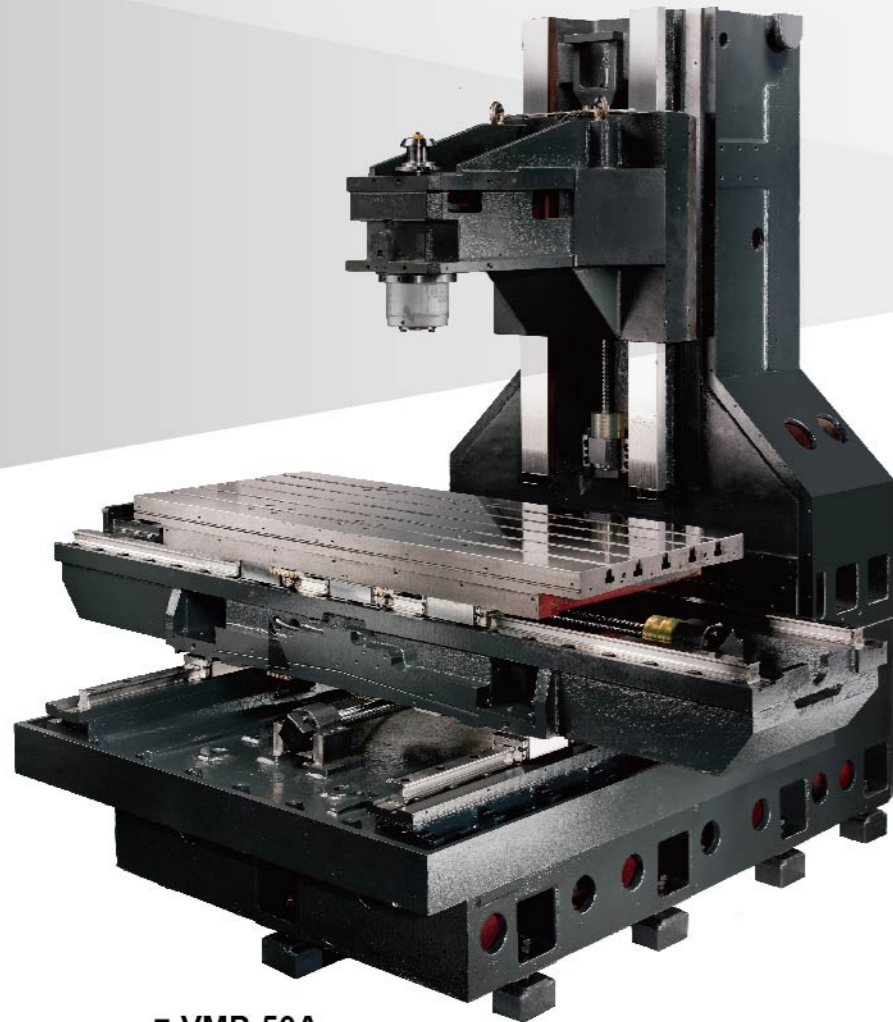

■ VMP-50A

Rear mounted Y-axis servo motor for increased maintenance space.

RUGGED CONSTRUCTION ASSURES OPTIMUM RIGIDITY AND STABILITY

- The machine structure and major parts are manufactured from Meehanite cast iron for outstanding material stability and assures long-term deformation-free performance.
- The entire machine construction is subjected to ANSYS and NASTRAN Finite Element Analysis to achieve optimum rigidity and stability.
- The column bottom is specially designed with A-shaped structure. (Except VMP23.30)
- Outstanding machine structure, combined with high speed servo system, allows rapid traverse up to 40 m/min.
- Servomotor directly drives ballscrew. Ballscrews are pretensioned, ensuring rigidity and accuracy required for the feed transmission system.
- Boxways for Z axis are coated with low friction Turcite B, providing increased cutting rigidity. (Except VMP23.30)
- 634mm span of guideways on Y-axis and 370mm span on Z-axis guarantee superior stability for saddle and spindle head travel.

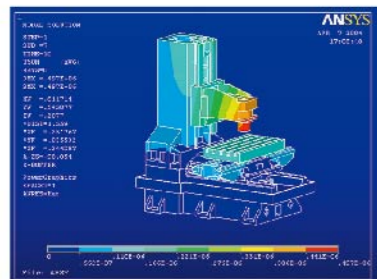
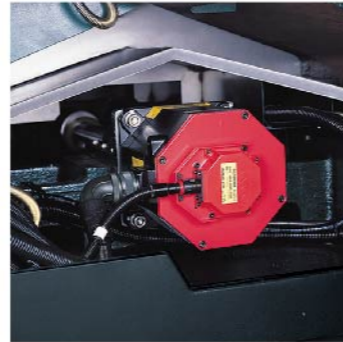

FEM ANALYSIS

FEELER'S machine structure is designed and analyzed using advanced Finite Element Analysis software for dynamic simulation and structural analysis. This design method assures optimum structural rigidity, machine accuracy and reliability.

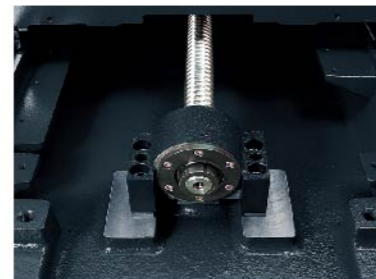

PRECISION BALLSCREWS

Pretensioned ballscrews on X, Y, Z axes ensure accuracy and eliminate positioning errors.

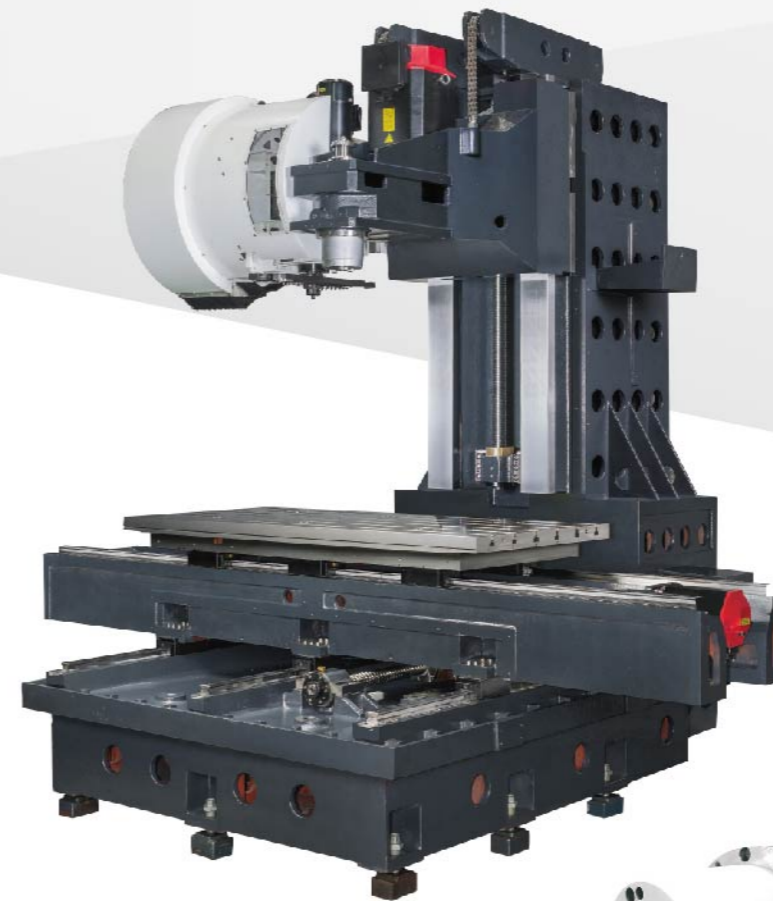
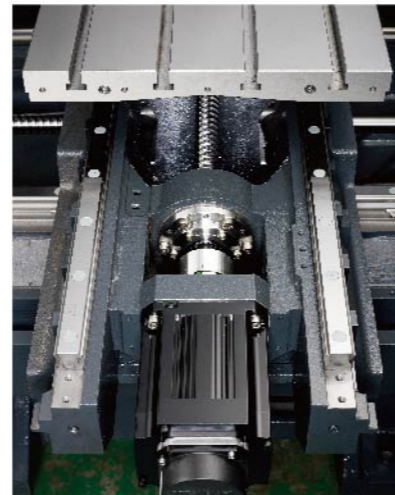

■ VMP-65A
(3 linear guide ways)



Dependable, Efficient ATC

FEELER'S ATC designs are all subjected to 1 million cycles of continuous tests for durability and stability to assure maximum dependability of operational performance.



10,000 RPM SPINDLE

The belt-drive spindle specially-designed bearing layout ensures maximum spindle rigidity. (Spindles at 10,000rpm and 12,000rpm are available as optional.)

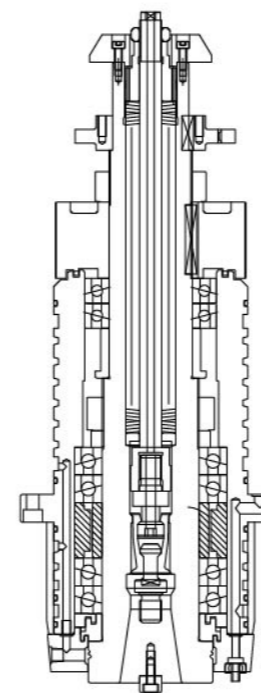

Cutting Capacity Example

Workpiece Material: Medium Carbon Steel (S45C)

Machining Types		
Drilling	Tapping	Face Milling
Tool Diam. (mm) x Feed (mm/rev)	Tool Diam. (mm) x Pitch (mm/rev)	Width (mm) x Depth (mm) x Feed (mm/min)
Ø40 x 0.1	M24 x 3.0	308 c.c. 80 x 3.5 x 1100

Pragmatic Operational Features

VARIOUS ADVANCED CNC CONTROLLERS TO CHOOSE FROM

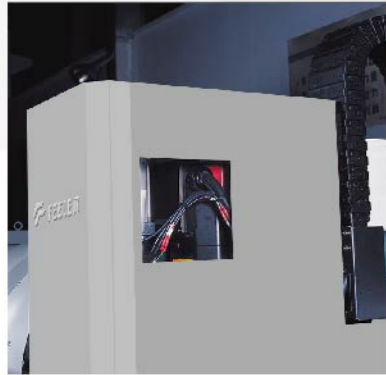

SEE-THROUGH WINDOW

The additional see-through window on the spindle head cover provides convenient checking.

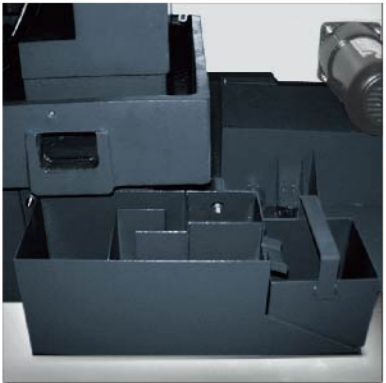

OIL / COOLANT SEPARATION DEVICE

Mounted at the side of the base, the oil/coolant separation device does not require additional leveling adjustment.

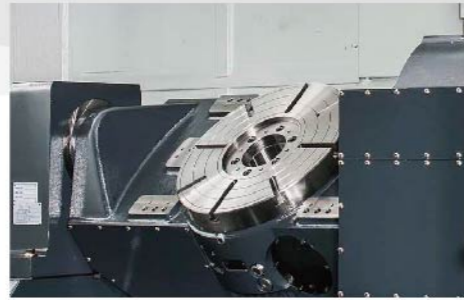

4+1 Axis(opt.)

CHIP CONVEYOR (opt.)

- * Chip conveyor of VMP series is with left side discharge (right side discharge is available upon request).
- * VMP32A/40A's chip conveyor is placed in front side with left side discharge, please refer to above drawing.
- * VMP23A/30A/45A/50A's chip conveyor is placed in the rear side of machine with left side discharge.

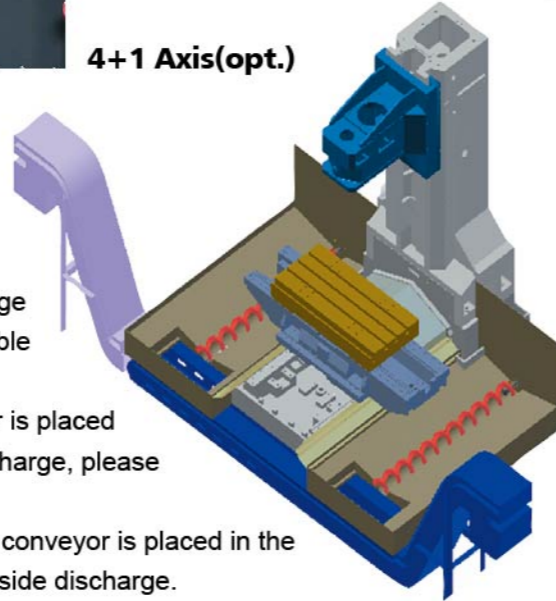

VMP-30 Rear Side Coolant Tank



VMP-40 Coolant Tank

VMP 32/40: 300L (Front side position)

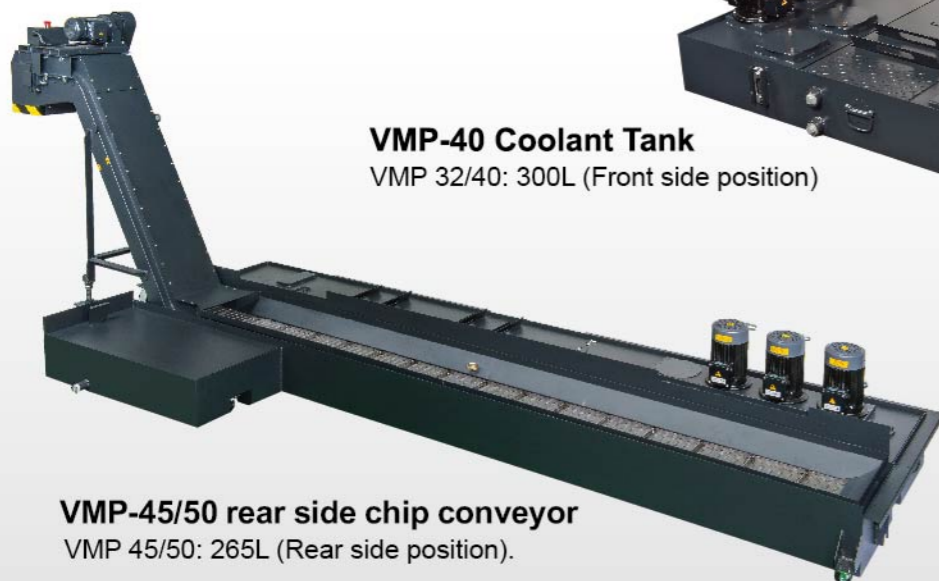

VMP-45/50 rear side chip conveyor

VMP 45/50: 265L (Rear side position).



FANUC Oi MF



MITSUBISHI M80



HEIDENHAIN iTNC 640



SIEMENS 828D

An Innovative Structural Design that Allows for Many Options

Mold Machining Package (OPT)

- 10,000 rpm spindle speed (Ceramic Bearing)
- 15/18.5 kW spindle power (Except VMP-23A/30A)
- 12 (24) m/min. rapid traverse on X / Y / Z-axis
- AICC + Data Server + Ethernet
- Servomotor upgrade

Precision Mold Machining Package (OPT)

- 10,000 rpm spindle speed (Ceramic Bearing)
- 15/18.5 kW spindle power (Except VMP-23A/30A)
- 12 (24) m/min. rapid traverse on X / Y / Z-axis
- 12,000 / 15,000 rpm DDS. spindle (Except VMP-23A/30A)
- Z-axis roller type linear guide
- HPCC+Data Servo + Ethernet + Manual guide i
- Jerk Control + Machining Conditions selection: 10-step speed change
- Servomotor upgrade
- Rear cover

INTELLIGENT PARAMETER ADJUSTMENT FUNCTION

The NC automatically evaluates and executes parameter compensation according to the machining condition.

1. BEFORE COMPENSATION

Sharp point occurs during quadrant change.

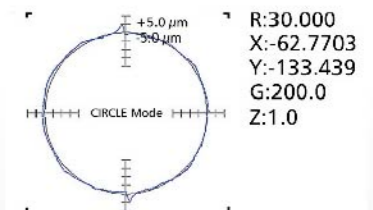

2. DURING COMPENSATION

The intelligent parameter adjustment function eliminates the sharp points on quadrants.

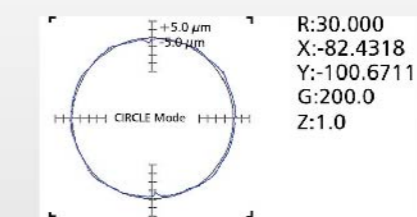

3. AFTER COMPENSATION

Circularity accuracy is greatly elevated.

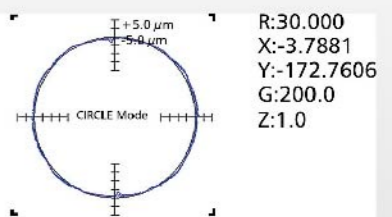

Machine Dimensions, Table Dimensions and Working Capacity

SERVO SYSTEM ADJUSTMENT AND OPTIMIZATION

The servo system can be adjusted to an optimum condition according to the signals from each axis movement. This provides:

- Increased servo system rigidity.
- Reduced machine vibration.
- Reduced machining time.
- Optimization for acceleration/deceleration time before and after interpolation.

This function meets the rigorous requirements of surface roughness and smoothness for the mold-making industry. Also, it greatly reduces machining time for maximum efficiency.

- BLUE CURVE: Torque command
- RED CURVE: Position
- GREEN CURVE: Speed
- PURPLE CURVE: Acceleration

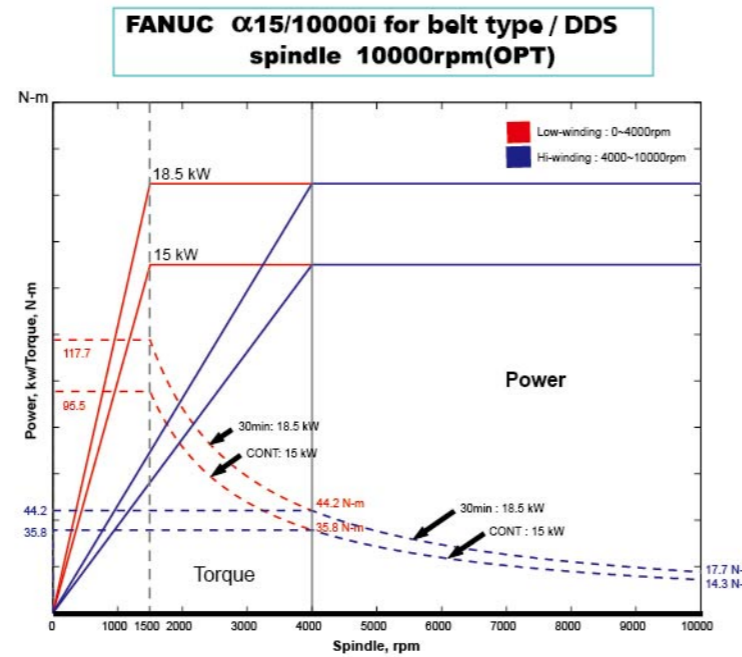
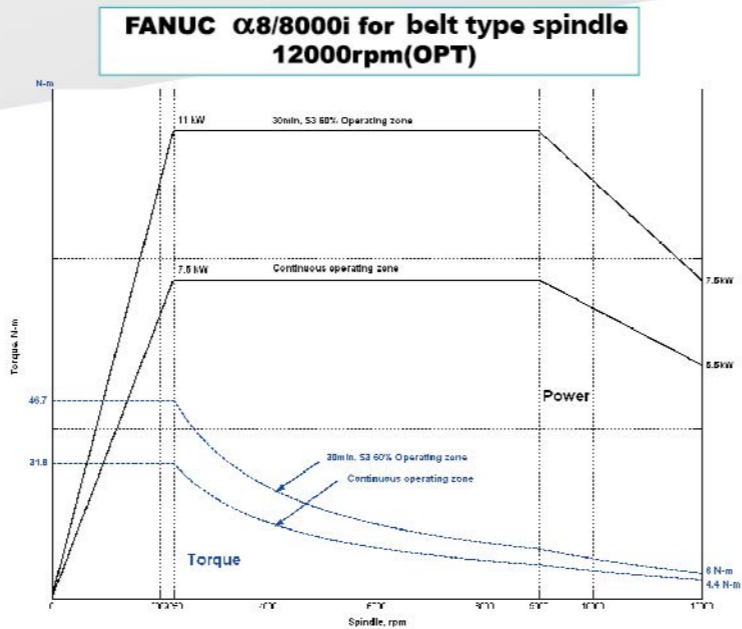
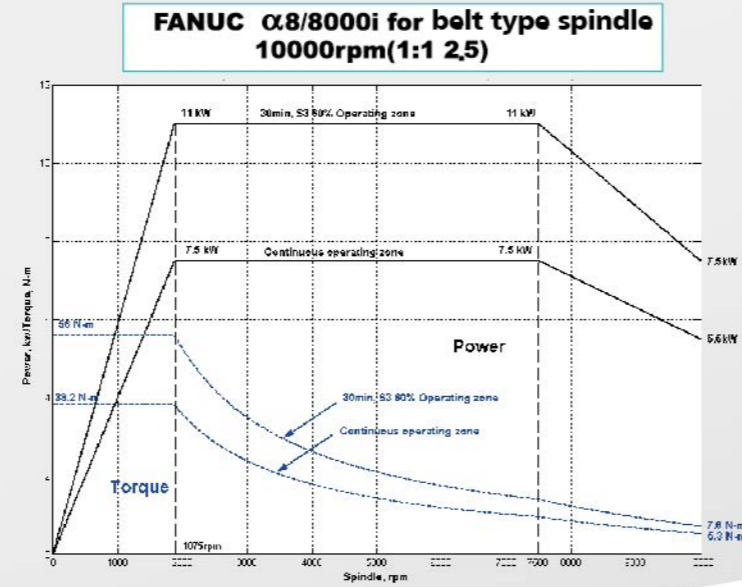
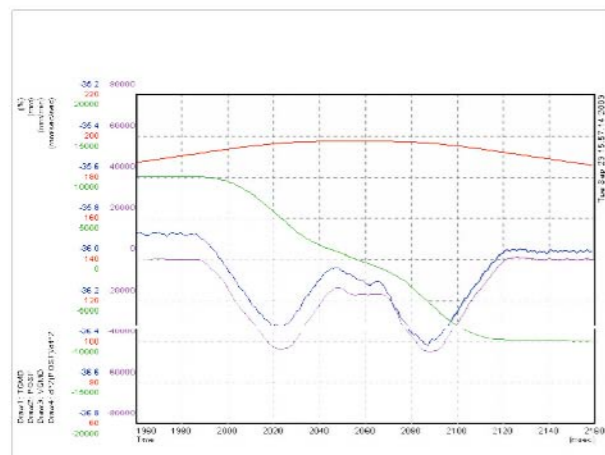
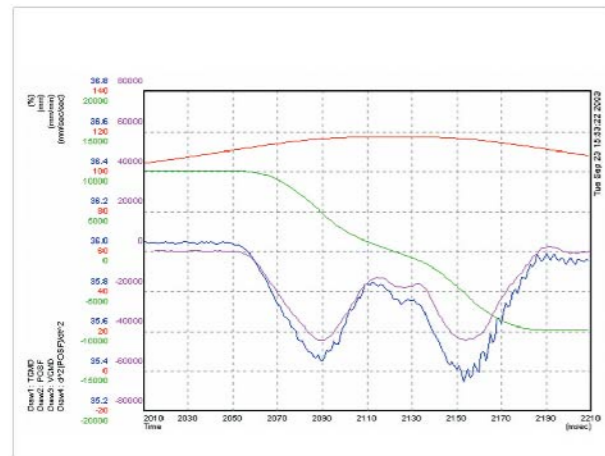

VMP-23 VMP-30

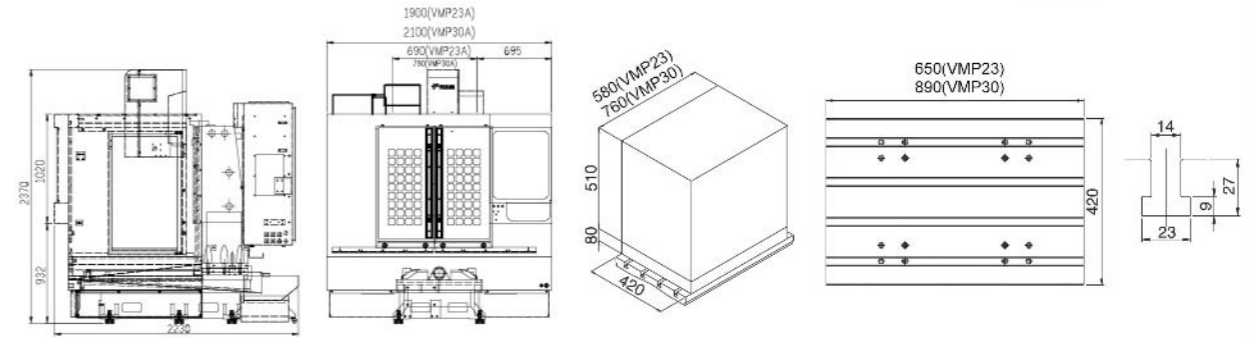

VMP-32 VMP-40

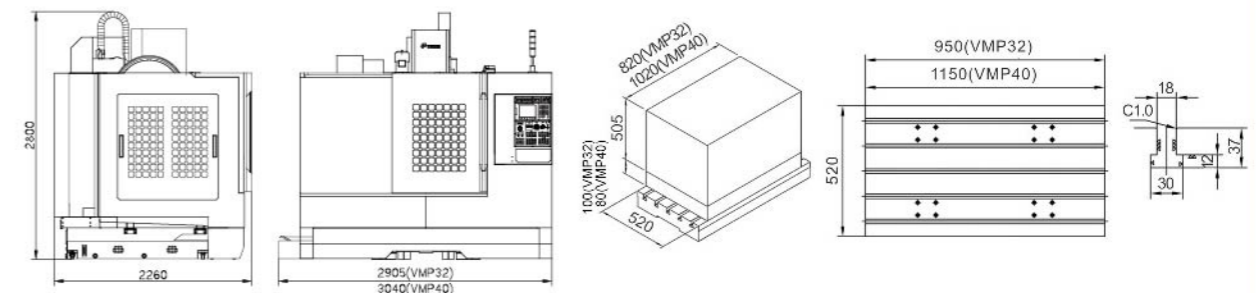

VM-45S

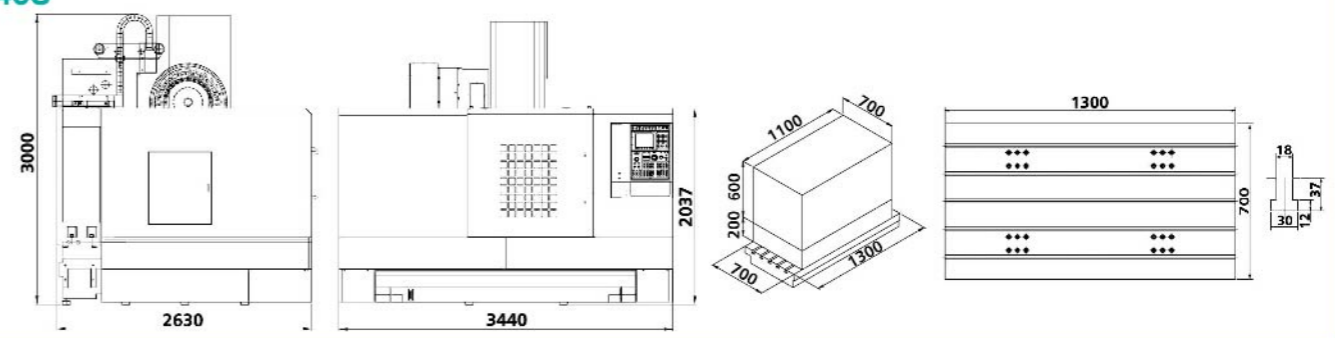

VMP-45 VMP-50

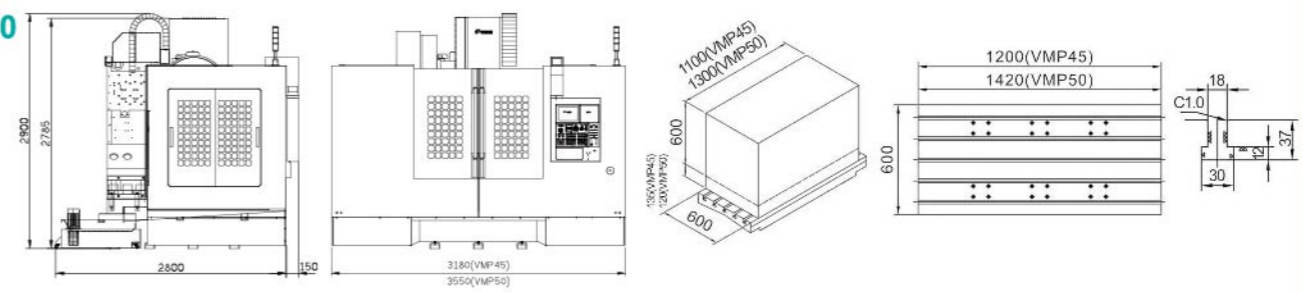

VMP-65

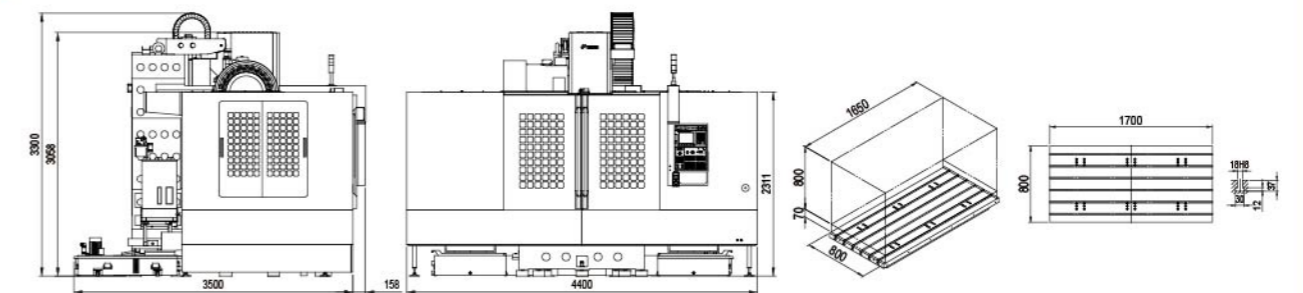

VMP MACHINE SPECIFICATIONS

MODEL	Unit	VMP-23(A)	VMP-23A-APC	VMP-30(A)	VMP-32(A)	VMP-32A-APC	VMP-40(A)	VM-45S(A)	VMP-45(A)		VMP-50(A)		VMP-65(A)
TRAVEL													
X - axis travel	mm	580	580	760	820	800	1,020	1,100	1,100		1,300		1,650
Y - axis travel	mm	420	420	420	520	520	520	700	610		610		800
Z - axis travel	mm	510	510	510	505 (OPT:635)		505	600	600		600		800
Spindle nose to table surface	mm	80 ~ 590	135 ~ 645	80-590	100 ~ 605 (OPT:80~715)		148 - 653	80 ~ 585 (OPT:80~715)	200 ~ 800		135 ~ 735		70~870
Spindle center to column surface	mm	455	455	455	560		560	770	660		660		850
Table surface to floor	mm	820	915	820	920		1025	940	950		975		1,080
Table center to column surface	mm	245 ~ 665	245 ~ 665	245 ~ 665	300 ~ 820		300 - 820	300 ~ 820	420 ~ 1,120		355 ~ 965		450~1,250
TABLE													
Table dimensions	mm	650 x 420	580 x 410	890x420	950 x 520		700 x 500	1,150 x 520	1,300 x 700		1,420 x 600		1,700x800
Maximum load	kg	300	120	300	800		200	800	1,000		1,500		1,500
T - slot	mm	14 x 4 x 100	35-M12xP1.75	14mm x 4 x 100	18 x 5 x 100		35-M16 x P2.0	18 x 5 x 100	18 x 5 x 125		18 x 5 x 100		18x6x125
SPINDLE													
Spindle speed	rpm	10,000	10,000	10,000	10,000		10,000	10,000	10,000		10,000		10,000
Spindle taper	type	7/24 taper No.40	7/24 taper No.40	7 / 24 taper No.40	7/24 taper No.40		7/24 taper No.40	7/24 taper No.40	7/24 taper No.40		7/24 taper No.40 / 7/24 taper No.50		7/24 taper No.40
Spindle power	kW	7.5 / 11	7.5 / 11	7.5 / 11	7.5 / 11		7.5 / 11	7.5 / 11	6 / 11		7.5 / 11		15/18.5
FEEDRATE													
X - axis rapid traverse	m / min	36	36	36	40		40	40	24		36		36
Y - axis rapid traverse	m / min	36	36	36	40		40	40	24		36		36
Z - axis rapid traverse	m / min	36	36	36	30		30	30	15		24		24
ATC													
Tool changing time	Carousel type	7 sec / 60 Hz, 7.1 sec / 50 Hz		No	7sec / 60Hz, 7.1sec / 50Hz		7 sec / 60 Hz, 7.1 sec / 50 Hz	7 sec / 60 Hz, 7.1 sec / 50 Hz	7 sec (No.40)		7 sec / 60 Hz, 7.1 sec / 50 Hz		7sec / 60 Hz, 7.1 sec / 50Hz
(tool-to-tool)	Arm type	1.7 sec / 60 Hz, 2.0 sec / 50 Hz		1.7 sec / 60 Hz, 2.0 sec / 50 Hz	1.7 sec / 60 Hz, 2.0 sec / 50 Hz		1.7 sec / 60 Hz, 2.0 sec / 50 Hz	1.7 sec / 60 Hz, 2.0 sec / 50 Hz	1.7 sec (No.40)		1.7 sec / 60 Hz, 2.0 sec / 50 Hz		1.7 sec / 60 Hz, 2.0 sec / 50 Hz
Tool changer		Carrousel (Arm)		Arm	Carrousel (Arm Type)		Carrousel (Arm)	Carrousel (Arm)	Carrousel (Arm)		Carrousel (Arm)		Carrousel(Arm)
No. of tools	type	18 (20)		20	18 (20)		22 (24)	22 (24)	22 (24)		22(24)		22(24)
Pull stud		P-40T (45°)		P-40T (45°)	P - 40T (45°)		P-40T (45°)	P-40T (45°)	P-40T (45°)		P-40T (45°) / P-50T (45°)		P-40T(45°)
Max. tool weight	kg	7		7	7		8	8	8		8 / 15		8
Max. tool length	mm	250		250	250		300	300	300		300 / 350		300
Max. tool diameter	mm	Ø80		Ø80	Ø80		Ø80	Ø80	Ø80		Ø80 / Ø100		Ø80
Max. Tool diameter (no adjacent tool)	mm	Ø130		Ø130	Ø130		Ø150	Ø150	Ø150		Ø150 / Ø200		Ø150
OTHERS													
Floor space	mm	1,900 x 2,255		1,900 x 2,630	2,100 x 2,255		2,905 x 2,260	3,300 x 3,175	3,040 x 2,260		3,440 x 2,630		4,400x3,500
Machine weight	kg	3,000		3,900	3,300		5,800	7500	6,300		9,000		11,000
Max. machine height	mm	2,370		2,520	2,370		2,800	2950	2,800		3,000		3,300
Power capacity	KVA	20		20	20		25	25	25		25		25
Air source	kg/cm ²	6-8		6-8	6-8		6-8	6-8	6-8		6-8		6-8

* APC changing time: 6 seconds/ VMP-23A-APC, 10 Seconds/ VMP32A-APC.
 * Specifications and design characteristics are subject to change without prior notice.

(Controller : Fanuc / Mitsubishi)

(Controller : Fanuc / Mitsubishi)

STANDARD ACCESSORIES

- Heat exchanger
- 3 axes pretensioned ballscrews
- Clamping / unclamping device
- Automatic lubrication system
- Fully enclosed splash guard
- Dust-proof electrical cabinet
- Spindle air sealing
- 3-color signal light
- Rigid tapping
- Leveling blocks and plates
- Spindle coolant nozzle
- Operation and maintenance manual

OPTIONAL ACCESSORIES

- 3 axes linear scales
- Coolant through spindle
- Workpiece measurement system
- Automatic tool length measurement and breakage detection
- Chip conveyor
- Chip screw
- Spindle oil cooler
- Flushing system + coolant gun
- Front flushing (VMP45/50)
- Top roof
- 4th axis preparation or rotary table
- High pressure pump
- Auto power off
- Rear cover
- 12,000rpm Belt type spindle BT-40
- 10,000rpm DDS spindle
- 12,000/15,000rpm DDS spindle
- Z axis travel Travel 635mm (VMP-32/40)

