

Valves without or with protecting cover are available with 3/2 and 4/2 function with or without detent.

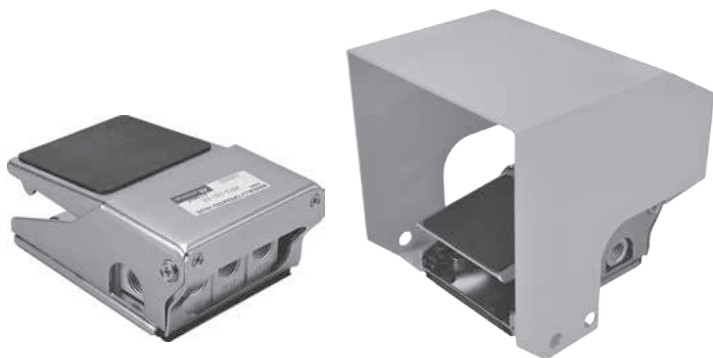

This valve series contains rubber gaskets.





Series	MVFA 240
Ports	G1/4"
Flow capacity [NI/min]	440
Working pressure [MPa]	0.2 to 0.7
Weight without / with protection cover [kg]	function 230: 0.684/1.426; function 231: 0.739/1.481; function 240: 0.774/1.516
Temperature range [°C]	ambient temperature -5 to +60

### Order codes

PMVFA 240 P L

Function	
230	 3/2 normally closed
231	 3/2 normally opened
240	 4/2

Protective cover	
	without protective cover
P	with protective cover

Detent	
	 without detent
L	 with detent

### Dimensions

#### Type without protecting cover

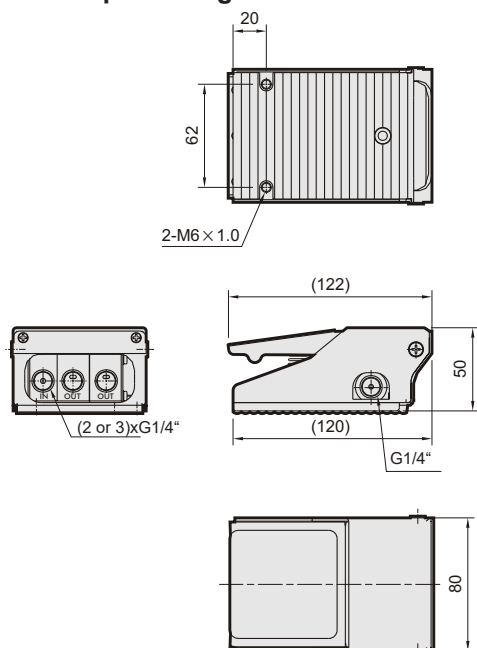

#### Type with protecting cover

